

Dish

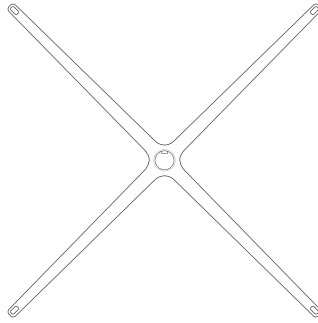

Base

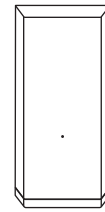

Power Supply

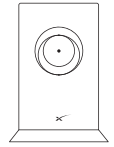

Router

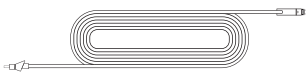

Starlink Cable
25 m
(82 ft)



Ethernet Cable
5 m
(16.5 ft)



Router Cable
2 m
(6.5 ft)



AC Cable (Power Supply)
1.8 m
(6 ft)



AC Cable (Router)
1.8 m
(6 ft)

STARLINK HIGH PERFORMANCE DISH

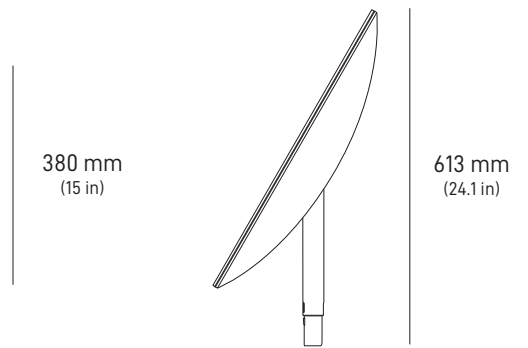
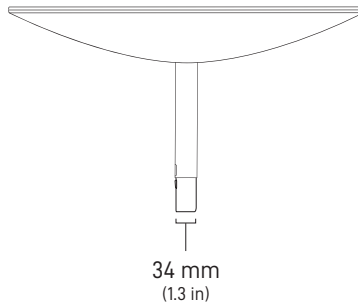
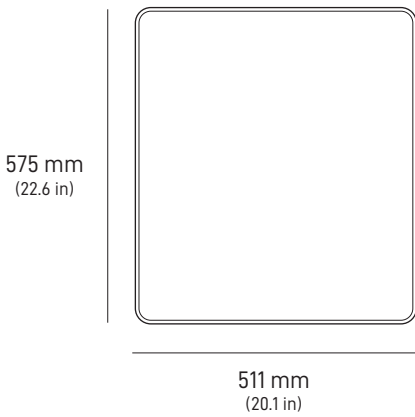

Antenna	Electronic Phased Array
Field of View	140°
Orientation	Motorized Self Orienting
Dish Weight	6.9 kg (15 lbs) without Cable 9.4 kg (21 lbs) with 25 m (82 ft) Cable
Environmental Rating	IP56
Operating Temperature	-30°C to 50°C (-22°F to 122°F)
Wind Speed	Operational: 80 kph+ (50 mph+)
Snow Melt Capability	Up to 75 mm / hour (3 in / hour)
Power Consumption	Average: 110-150 W
Wi-Fi	Dual Band Wi-Fi 5 - 3x3 MIMO
User LAN	RJ45 Cable

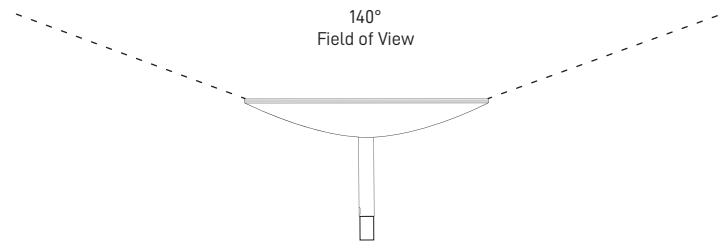

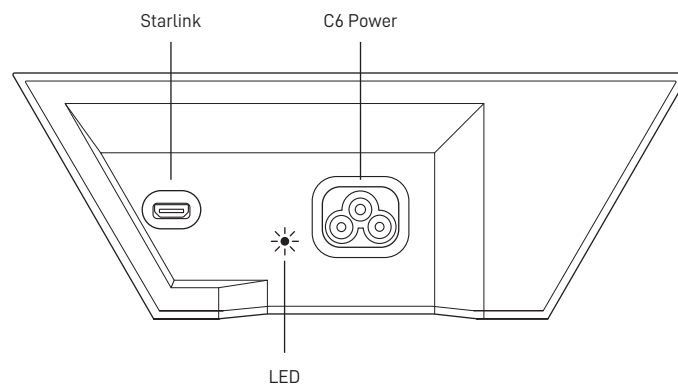
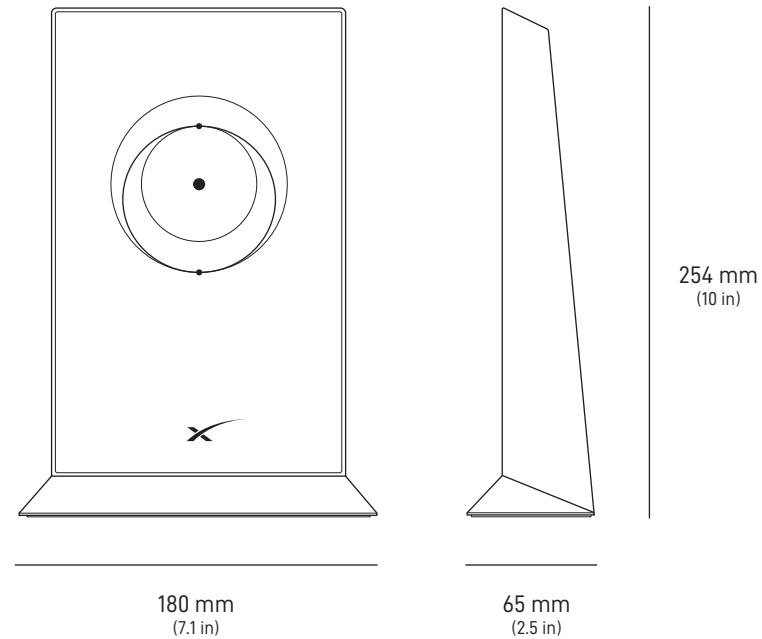

Wi-Fi Technology	802.11ac Dual Band
Generation	Wi-Fi 5
Radio	Dual Band -3 x 3 MIMO
Operating Temperature	-30°C to 50°C (-22°F to 122°F)
Weight	1 kg (2.2 lbs)
Security	WPA2
Range	Up to 185 m ² (2000 ft ²) *Varies on placement, interference, and materials
Environmental Rating	IP54 - Configured for Indoor Use
Power Indicator	White LED Base of Router
Mesh Compatibility	Compatible with up to 12 Starlink Nodes
Devices	Connect up to 128 devices

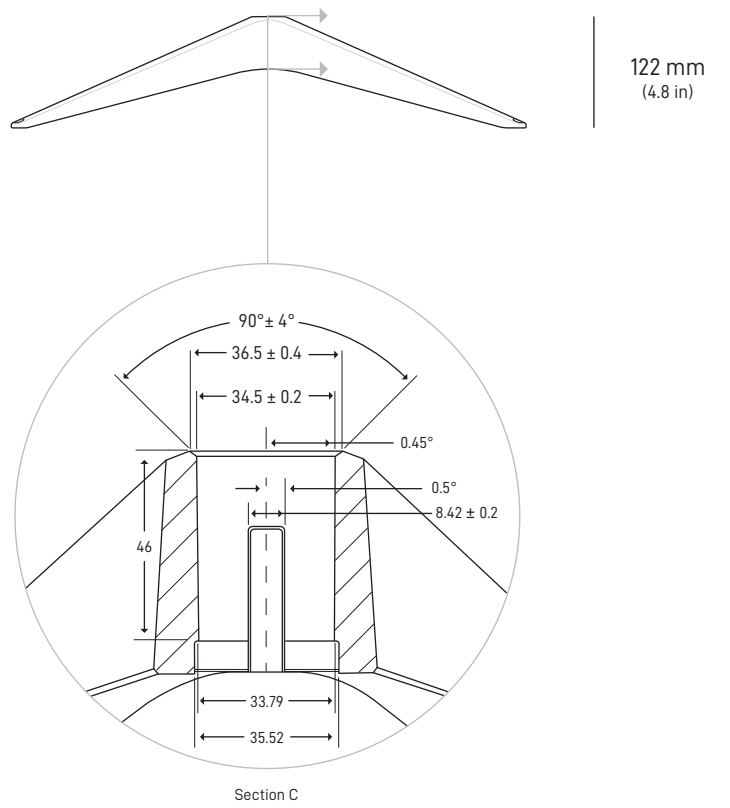
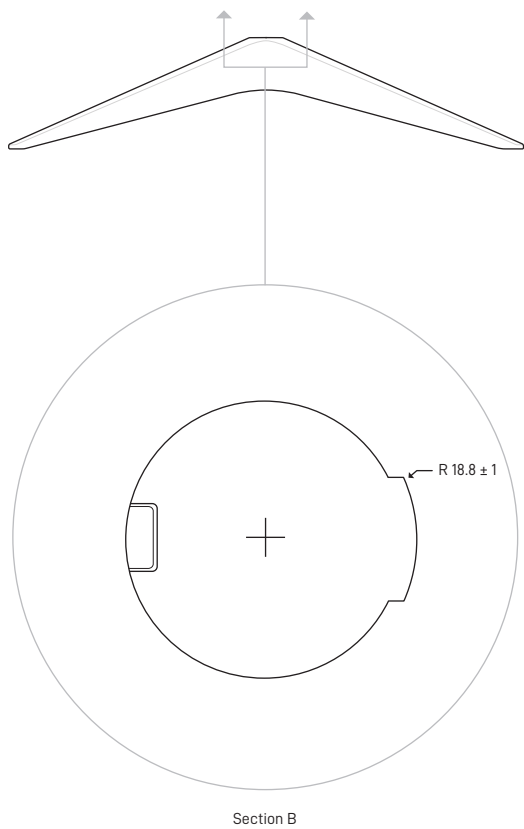
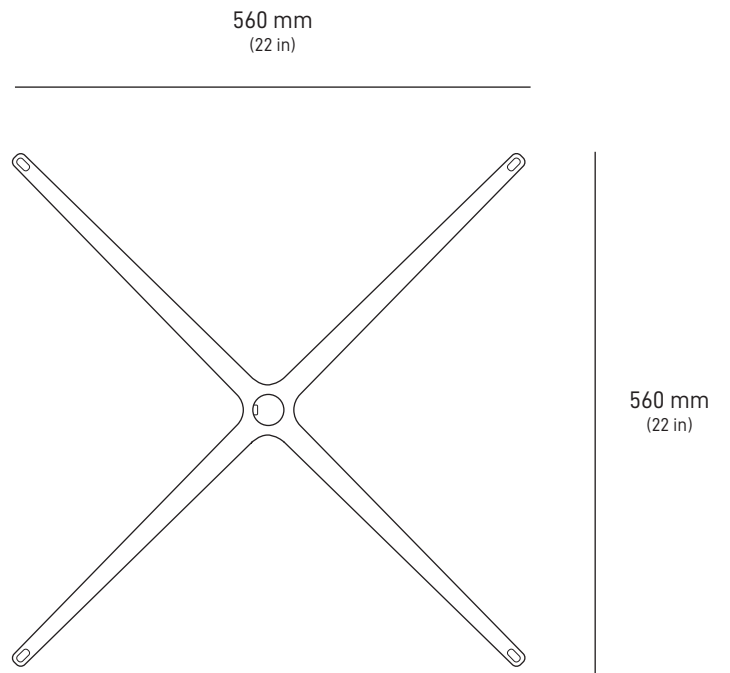
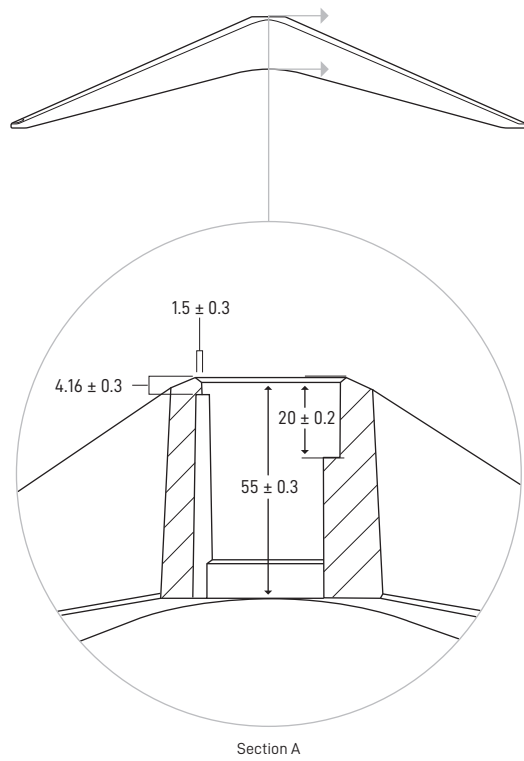

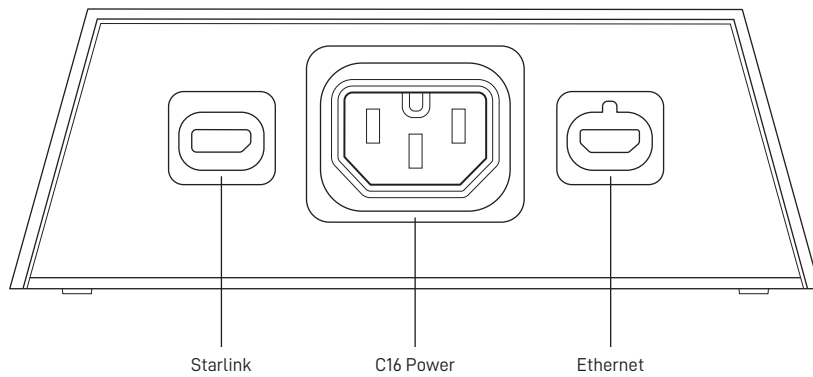
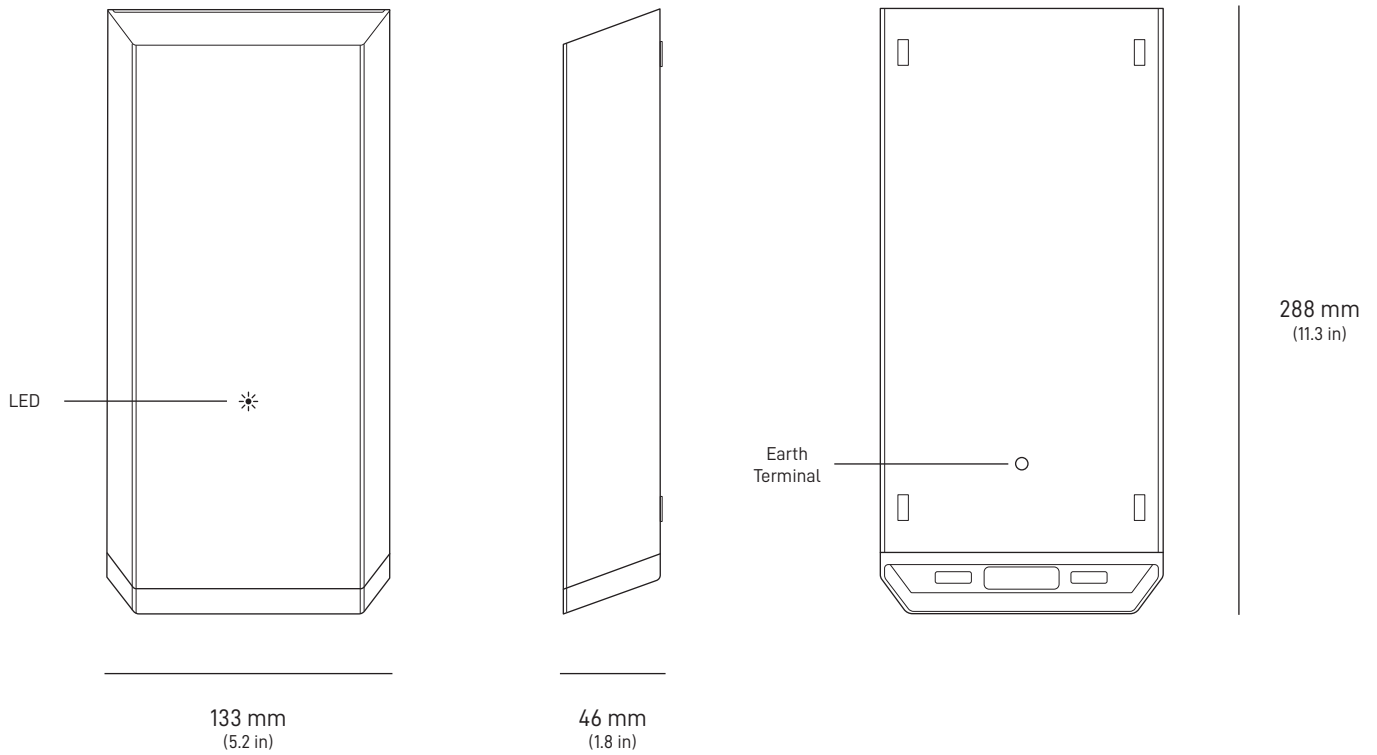

Environmental Rating	IP56
Operating Temperature	-30°C to 50°C (-22 to 122°F)
Weight	1.5kg (3lbs)
Grounding	Dedicated Earth Terminal
Power Specifications	100-240V - 6.3A 50 - 60 Hz
Mounting	Included Wall Mount

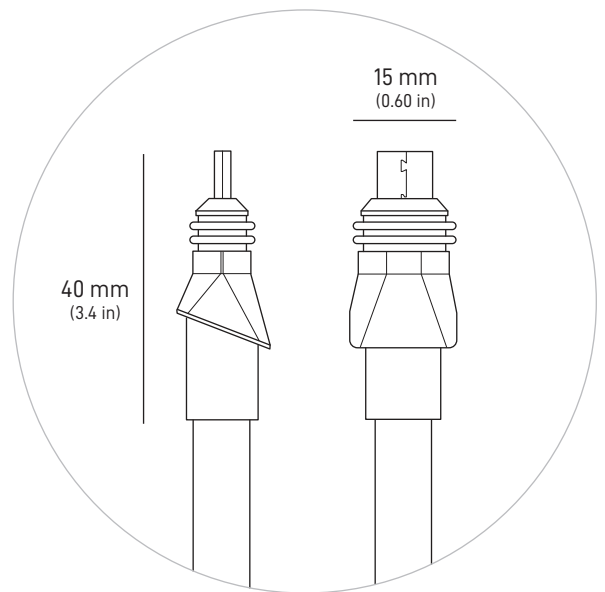
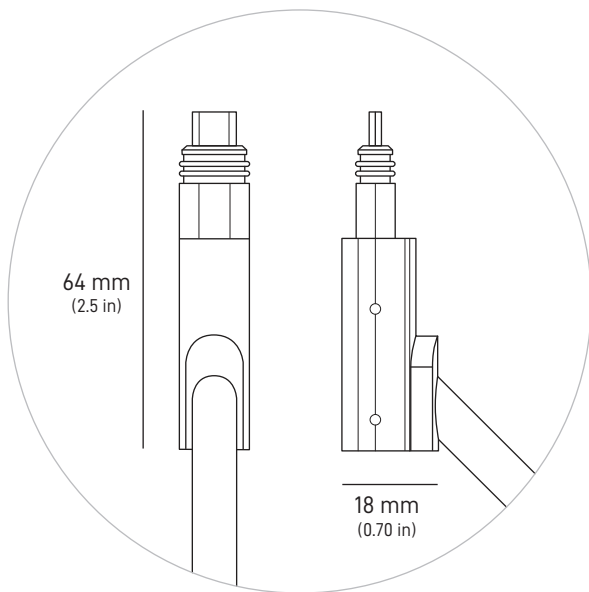
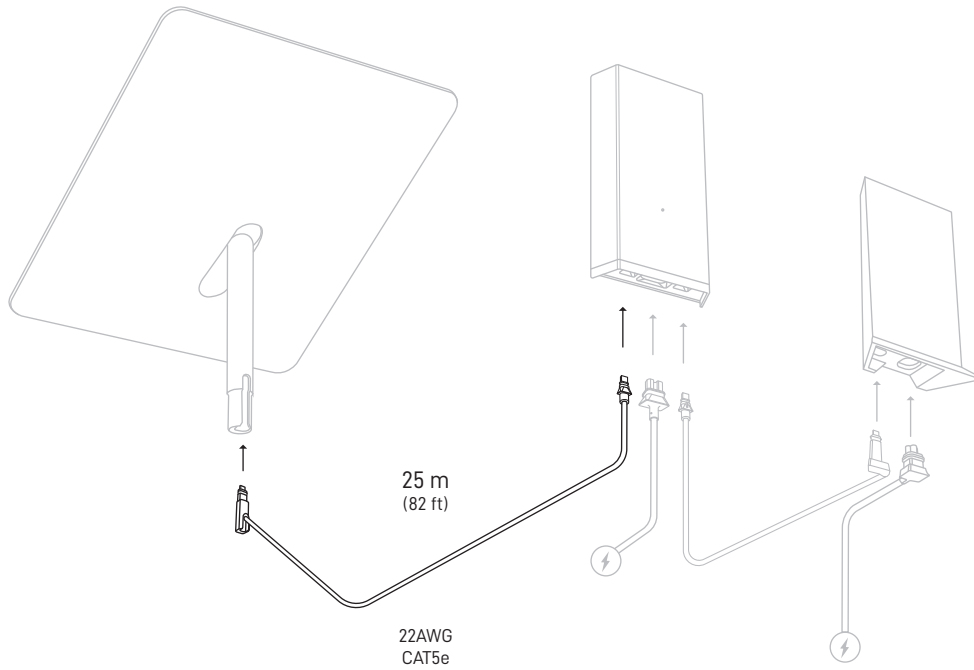

End	Pin	Wire Color	Pin	End
Dish	A1	Green	A1	Power Supply
	A2	Yellow	A2	
	A3	Blue	A3	
	A4	White	A4	
	B1	Orange	B1	
	B2	Purple	B2	
	B3	Brown	B3	
	B4	Gray	B4	
	B5	Shield / Shell	B5	

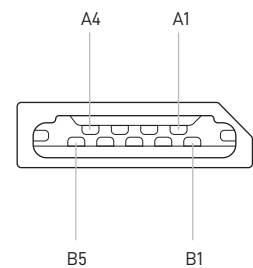

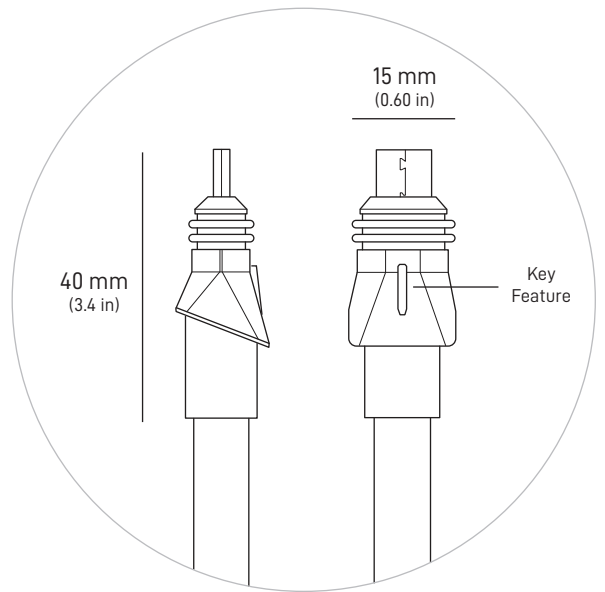
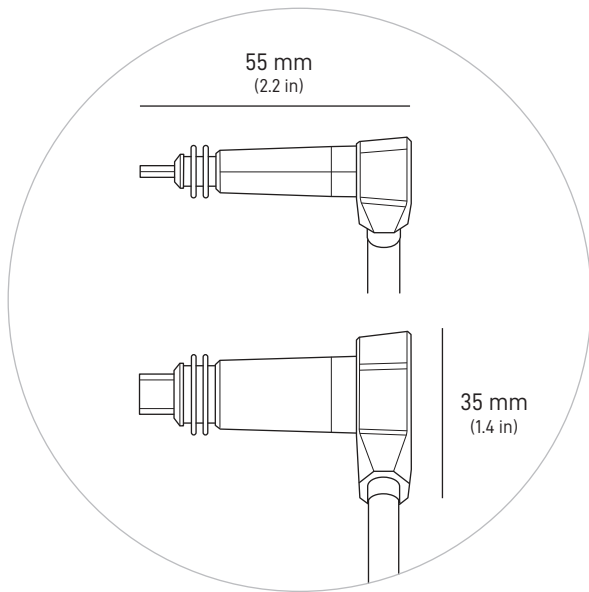
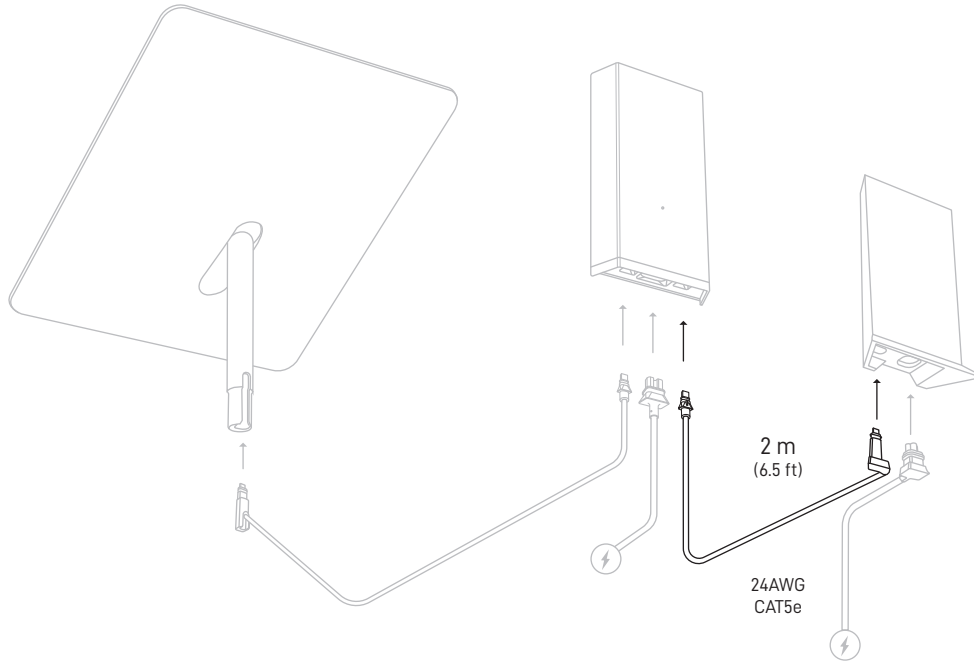

End	Pin	Ethernet Pin	Wire Color	Pin	End
Wi-Fi	A1, A2	B+	Orange White	A1, A2	Power Supply
	A3, A4	B-	Orange	A3, A4	
	A5, A6	A+	Green White	A5, A6	
	A7, A8	A-	Green	A7, A8	
	B1, B2	--	N / C	B1, B2	
	B3, B4	--	N / C	B3, B4	
	B5	D+	Brown White	B5	
	B6	D-	Brown	B6	
	B7	C-	Blue White	B7	
	B8	C+	Blue	B8	
	B9, B10	--	N / C	B9, B10	
	B11, B12	--	N / C	B11, B12	
	Shield Can		Drain Wire	Shell	

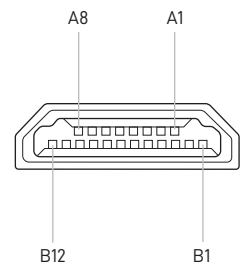

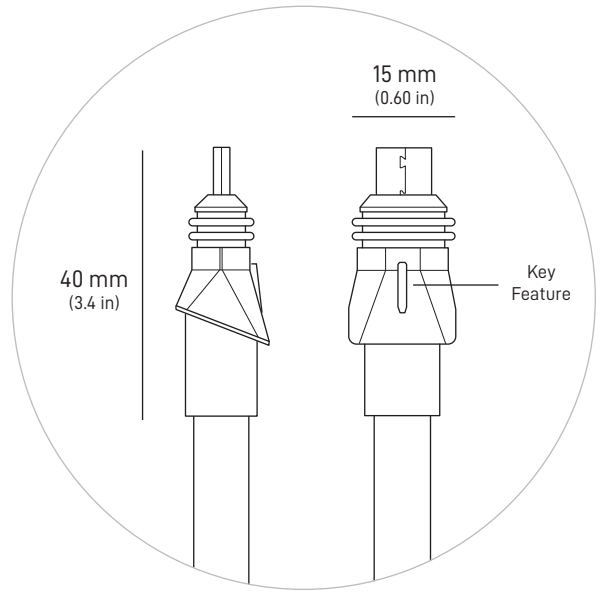
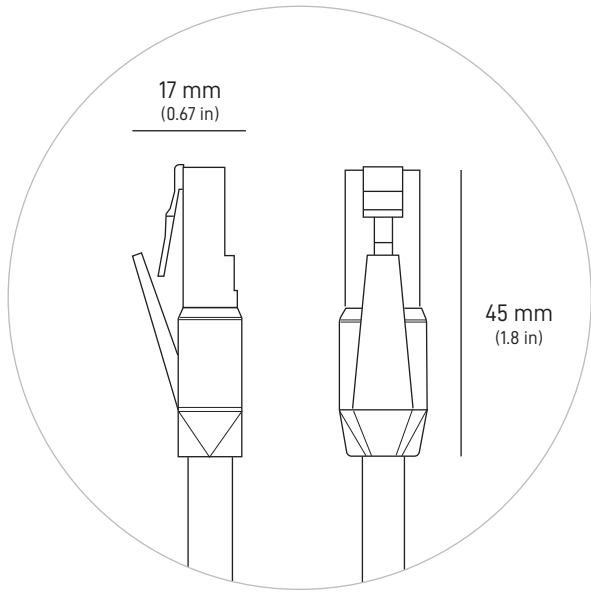
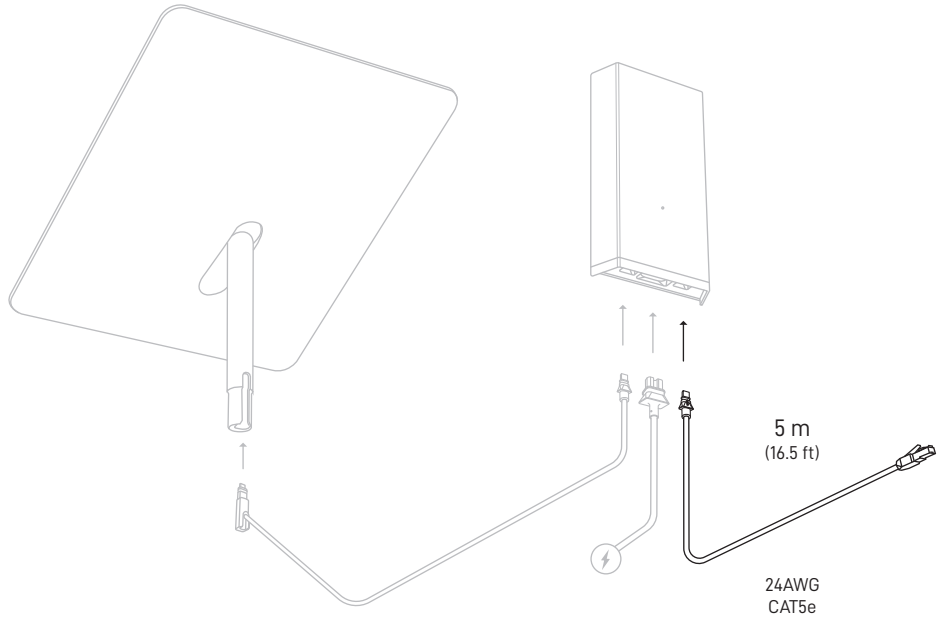

End	Pin	Ethernet Pin	Wire Color	Pin	End
RJ45	A1, A2	B+	Orange White	A1, A2	Power Supply
	A3, A4	B-	Orange	A3, A4	
	A5, A6	A+	Green White	A5, A6	
	A7, A8	A-	Green	A7, A8	
	B1, B2	--	N / C	B1, B2	
	B3, B4	--	N / C	B3, B4	
	B5	D+	Brown White	B5	
	B6	D-	Brown	B6	
	B7	C-	Blue White	B7	
	B8	C+	Blue	B8	
	B9, B10	--	N / C	B9, B10	
	B11, B12	--	N / C	B11, B12	
	Shield Can		Drain Wire	Shell	

